

フタ本体 (S=1/10)

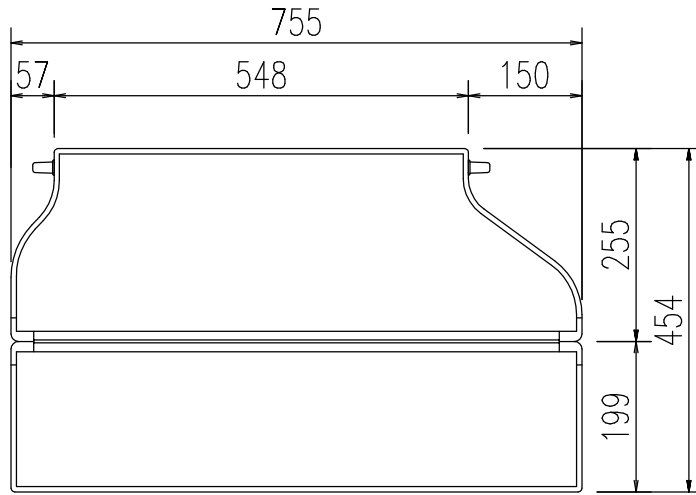

固定部品L (S=1/5)

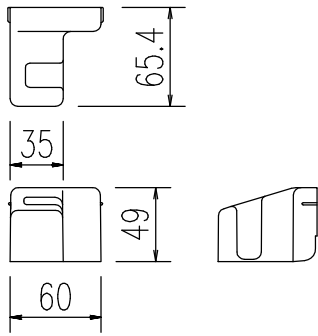

固定部品R (S=1/5)

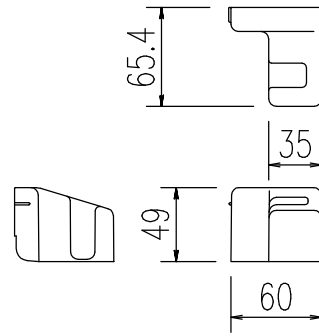

ダボ (S=1/1)

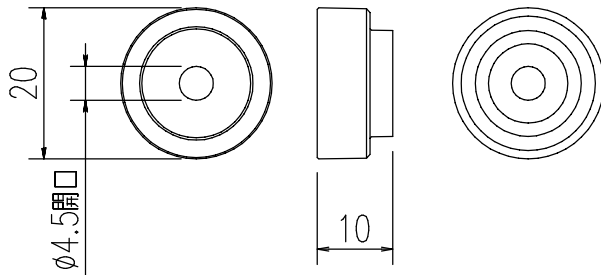

ダボカバー (S=1/1)

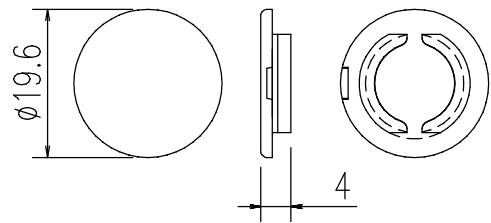

M4小ねじ (S=1/1)

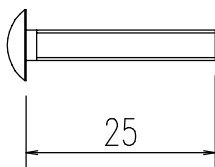

ワッシャー (S=1/1)

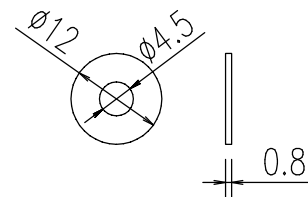

特記事項	品名	図面	担当	検図	図番
	組蓋				日付
	品番	尺度			
	YFK-0576A(1)R-D-B	1/10			